

# Goalrilla™

BASELINE WALL MOUNT  
FOR **54" / 60" / 72"**  
BACKBOARDS



**Please Do Not Return This Product to the Store!**

Contact Goalrilla Australia customer service department at:  
Phone: 1-800-551-443  
E-mail: [information@goalrilla.com.au](mailto:information@goalrilla.com.au)

**ESCALADE®**  
SPORTS

Escalade® Sports products may be manufactured and/or licensed under the following patents.  
6120397, 5816957, 5769744, 5119741, 4911085, 4717157, D460140, D420563, 8414431  
Additional patents may be pending. One or more of the listed patents and/or pending patents may cover specific product.

2L-7658-00

2018 Escalade® Sports

## PRE-ASSEMBLY TIPS

1. **Read this manual carefully before starting assembly.** Read each step completely before beginning each step. **CONSULT A STRUCTURAL ENGINEER OR BUILDER ON THE MOUNTING OF THIS UNIT AND THE HARDWARE REQUIRED TO DO SO. AVOID ATTACHING TO ANY BRICK SURFACE OR FACADE.**
2. Some smaller parts may be shipped inside larger parts. Check inside all parts and cartons before assembling or ordering parts.
3. To make assembly easier, use the Hardware Identifier on page 6 to identify and sort all fasteners. Check all cartons for kits. All hardware may not be located in one kit.
4. Do not tighten hardware until instructed to do so. If hardware is tightened too soon, mounting holes may not align and parts may not easily fit together. Leave locknuts slightly loose until you are instructed to tighten them.
5. An electric screwdriver is helpful in assembly. However, please set at low torque and use caution because you could overtighten the hardware and strip the screws.
6. Save these instructions and your proof of purchase (receipt) in the event that the manufacturer has to be contacted for replacement parts.

### TOOLS NEEDED FOR ASSEMBLY

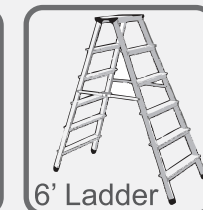
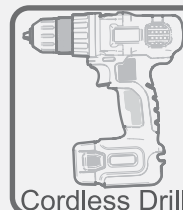
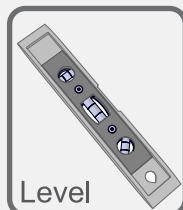
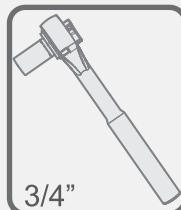
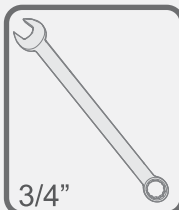

**Please Do Not Return This Product To The Store!**

Goalrilla Australia customer service department at:

Phone: 1-800-551-443

E-mail: [information@goalrilla.com.au](mailto:information@goalrilla.com.au)

Please visit our Website at:  
[www.goalrilla.com.au](http://www.goalrilla.com.au)

## CAUTION

CONSULT A STRUCTURAL ENGINEER OR BUILDER ON THE MOUNTING OF THIS UNIT AND THE HARDWARE REQUIRED TO DO SO. AVOID ATTACHING TO ANY BRICK SURFACE OR FACADE.

## WARNING

FAILURE TO FOLLOW THESE WARNINGS MAY RESULT IN SERIOUS INJURY AND/OR PROPERTY DAMAGE.

Owner must ensure that all players know and follow these rules for safe operation of the system.

- Only hang from the rim briefly to regain balance or avoid injuring others. Release the rim as soon as safely possible.
- During play, especially when performing dunk type activities, keep player's face away from the backboard, rim, and net. Serious injury could occur if teeth/face come in contact with backboard, rim, or net.
- When adjusting height, keep hands and fingers away from moving parts.
- Do not allow children to adjust system.
- During play, do not wear jewelry (rings, watches, necklaces, etc.) Objects may entangle in net.
- Once a month check all metal parts for rust. Completely remove rust and repaint with exterior enamel. If rust has penetrated any steel part, replace that part immediately.
- Check system before each use for loose hardware, signs of rust and instability. Repair before each use. Never play on damaged equipment.
- Wear a mouthguard when playing to avoid dental injuries.



## SAFETY INSTRUCTIONS



FAILURE TO FOLLOW THESE WARNING MAY RESULT IN SERIOUS INJURY AND/OR PROPERTY DAMAGE. Owner must ensure that all players know and follow these rules for safe operation of the system.



## SAFETY INSTRUCTIONS



FAILURE TO FOLLOW THESE SAFETY INSTRUCTIONS MAY RESULT IN SERIOUS INJURY, PROPERTY DAMAGE AND WILL VOID WARRANTY.

Owner must ensure that all players know and follow these rules for safe operation of the system.

To ensure safety, do not attempt to assemble this system without following the instructions carefully. Proper and complete assembly, use and supervision is essential for proper operation and to reduce the risk of accident or injury. A high probability of serious injury exists if this system is not installed, maintained, and operated properly.

- If using a ladder during assembly, use extreme caution.
- 4 people are recommended for this operation.
- Seat the pole sections properly (if applicable). Failure to do so could allow the pole sections to separate during play.
- Before digging contact utility company to locate underground power cables, gas and water lines. Ensure there are no overhead power lines within 20 ft. (7m) radius of pole location.
- Climate, corrosion or misuse could result in system failure.
- If technical assistance is required, contact the manufacturer.
- Minimum operational height is 6'6" (1.98m) to the bottom of backboard.

*Most injuries are caused by misuse and/or not following instructions.  
Use caution when using this system.*

**WARNING!**  
Failure to observe this warning may cause property damage and/or serious injury.

Only hang from the rim briefly to regain balance or avoid injuring others. Release the rim as soon as safely possible. Rim height adjustments should be made under parental supervision. Wear a mouth guard when playing to avoid dental injuries. During play, do not wear jewelry (rings, watches, necklaces, etc). Objects may entangle in net.

(Affixed to backboard)



**WARNING: IMPROPER  
INSTALLATION OR SWINGING  
ON THE RING MAY CAUSE  
SERIOUS INJURY OR DEATH**

**PARTS LIST (NOT ACTUAL SIZE)**

**BACKBOARD SIZE DEPENDS ON SIZE ORDERED**

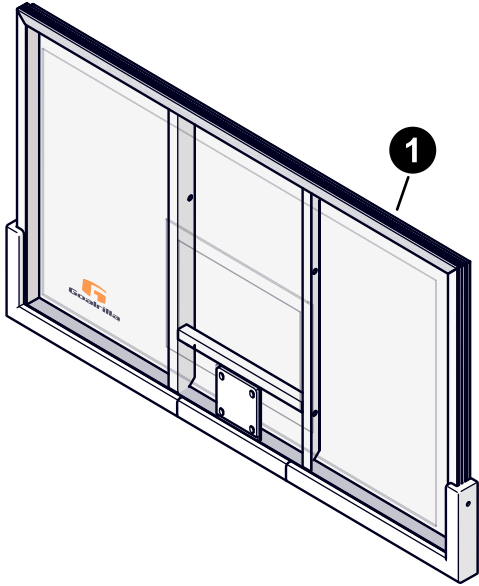

**72" BACKBOARD WITH PAD  
B7102AF  
(QTY. 1)**

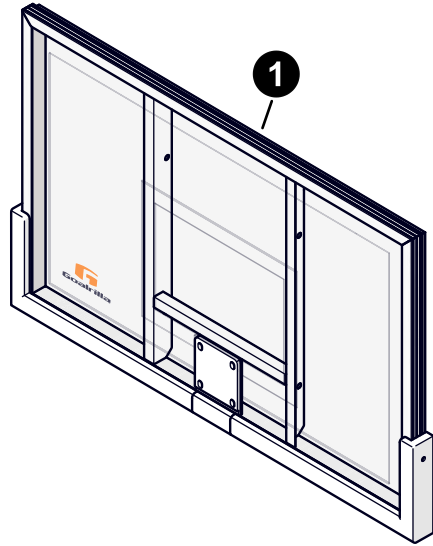

**60" BACKBOARD WITH PAD  
B7101AF  
(QTY. 1)**

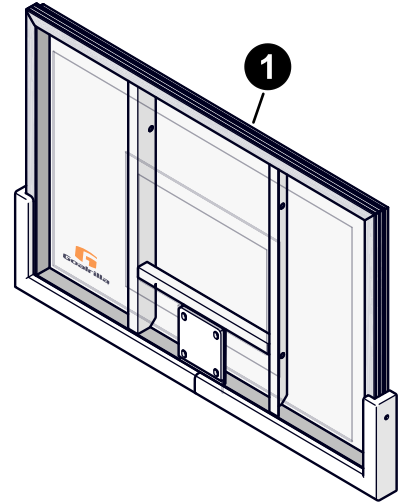

**54" BACKBOARD WITH PAD  
B7100AF  
(QTY. 1)**

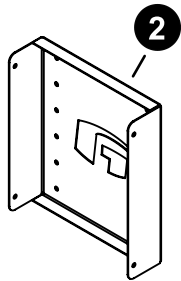

**BASELINE WALLMOUNT  
2S-9432-00  
(QTY. 1)**

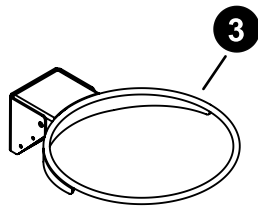

**GOAL ASSEMBLY  
6A-6328-02  
(QTY. 1)**

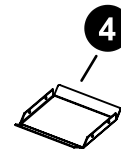

**RIM COVER PLATE  
2S-6241-00  
(QTY. 1)**

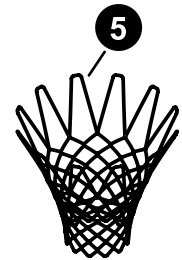

**NET  
3F-6010-00  
(QTY. 1)**

# HARDWARE IDENTIFIER (ACTUAL SIZE)

## HARDWARE NEEDED FOR MAIN ASSEMBLY

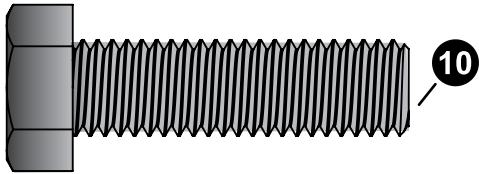

1/2-13 X 1 3/4" HEX BOLT  
1B-6224-10  
(QTY. 4)

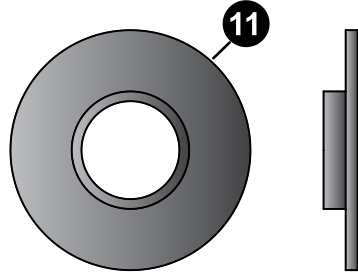

NYLON WASHER WITH  
ADHESIVE (1/2" ID)  
7B-6549-00  
(QTY. 12)

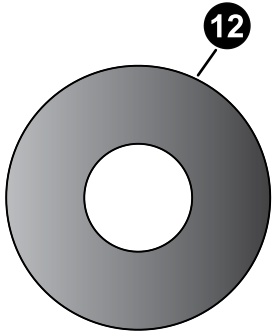

1/2" FLAT WASHER  
2B-6093-10  
(QTY. 8)

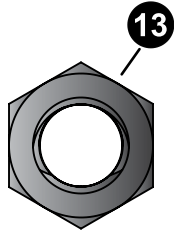

1/2-13 LOCKNUT  
2B-6095-10  
(QTY. 4)

## HARDWARE NEEDED FOR RIM ASSEMBLY

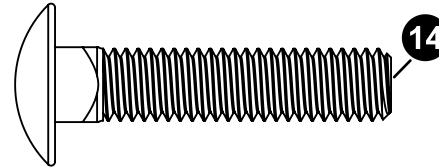

3/8-16 X 1 3/4" CARRIAGE BOLT  
1B-6782-10  
(QTY. 4)

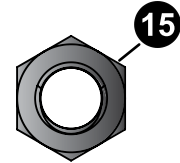

3/8-16 LOCKNUT  
2B-6238-10  
(QTY. 4)

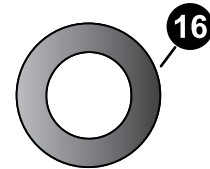

3/8" X 19MM FLAT WASHER  
2B-6289-10  
(QTY. 4)

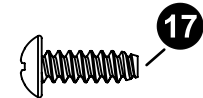

#8 X 1/2" THREAD  
FORMING SCREW  
1B-6238-01  
(QTY. 4)



## CAUTION

CONSULT A STRUCTURAL ENGINEER OR BUILDER ON THE MOUNTING OF THIS UNIT AND THE HARDWARE REQUIRED TO DO SO. AVOID ATTACHING TO ANY BRICK SURFACE OR FACADE.

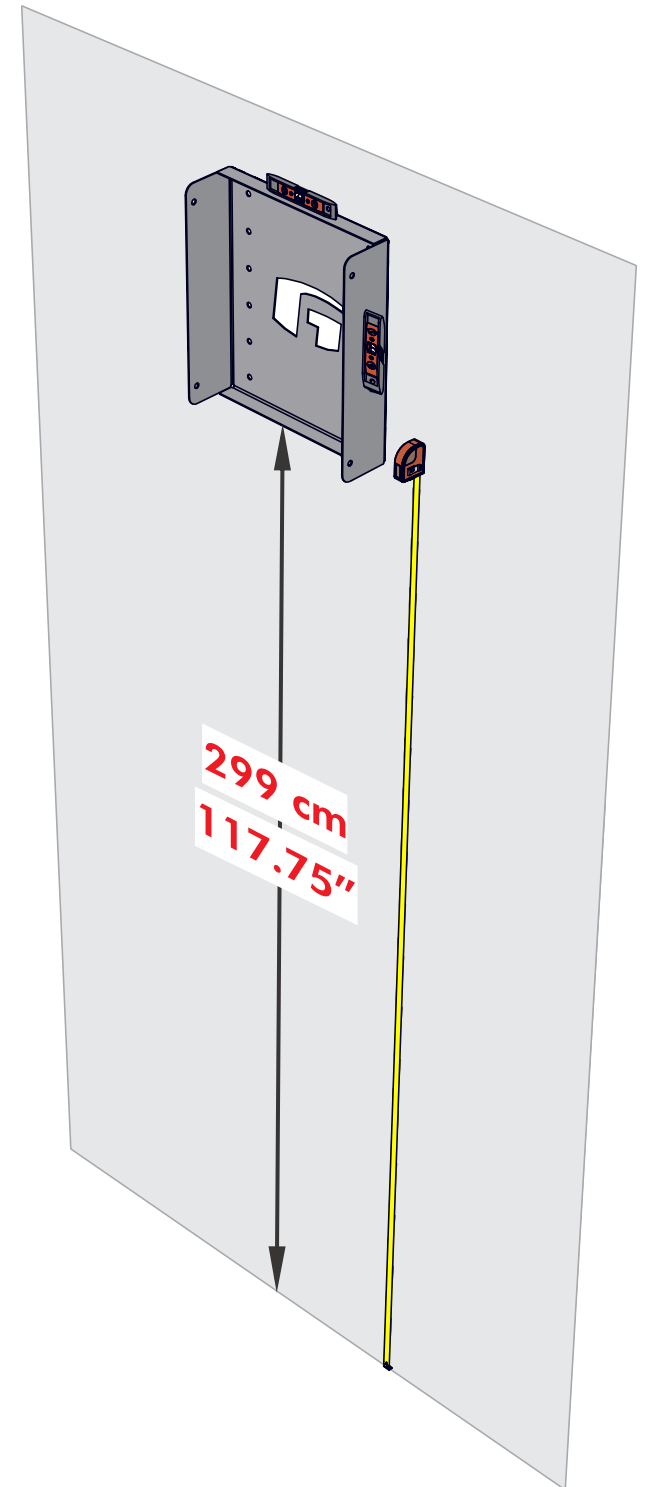

**HARDWARE NEEDED (ACTUAL SIZE)**

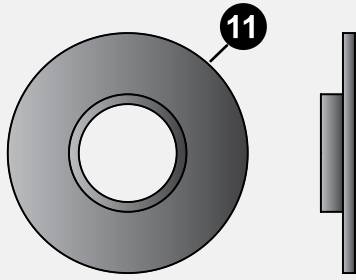

NYLON WASHER WITH  
ADHESIVE (1/2" ID)  
7B-6549-00  
**(QTY. 4)**

Peel nylon washers (#11) and insert to the OUTSIDE of the backboard mounting brackets as shown.

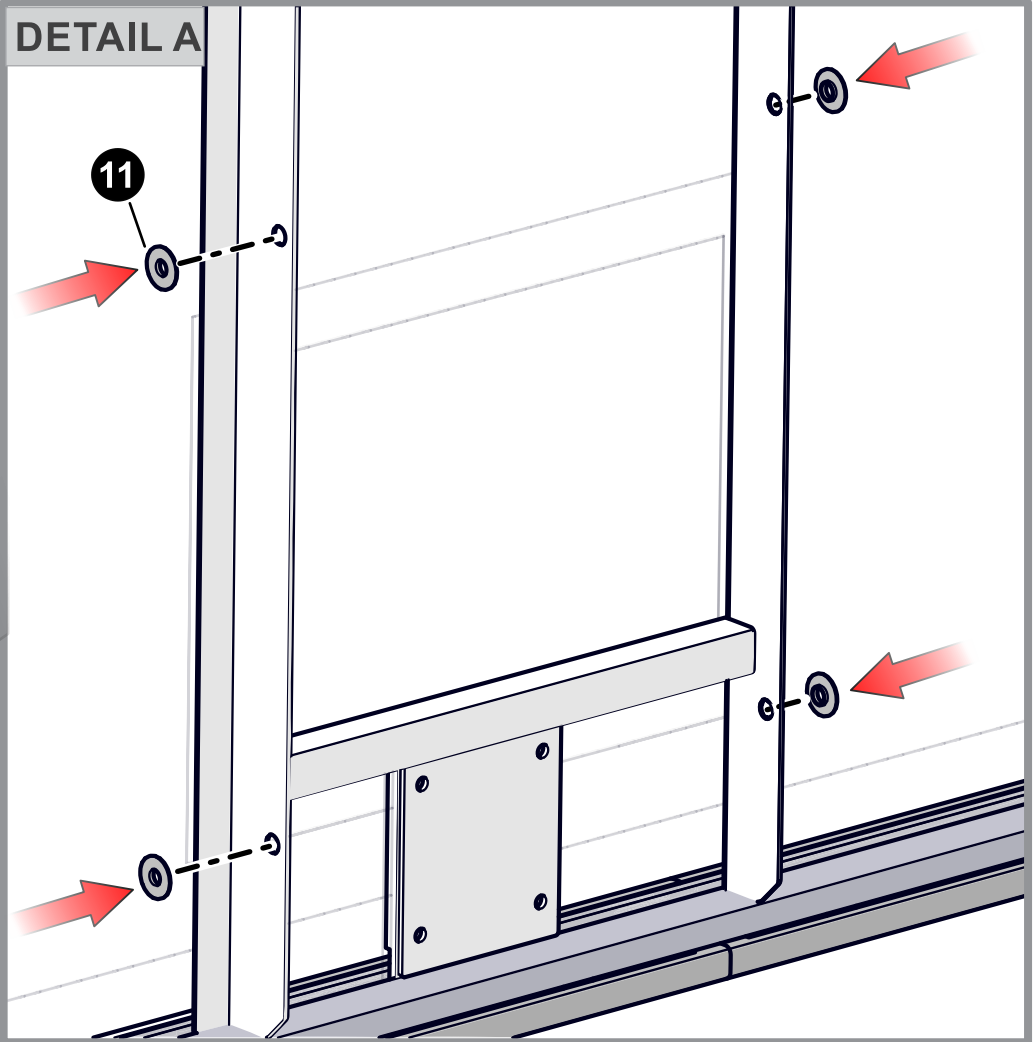

**BACK VIEW**





## TOOLS NEEDED



## ! CAUTION !

ATTACHING THE BACKBOARD TO WALL MOUNT  
REQUIRES AT LEAST FIVE CAPABLE ADULTS.  
FOUR TO LIFT IT UP THE BACKBOARD AND ONE  
TO PLACE AND TIGHTEN THE HARDWARE.

## HARDWARE NEEDED (ACTUAL SIZE)

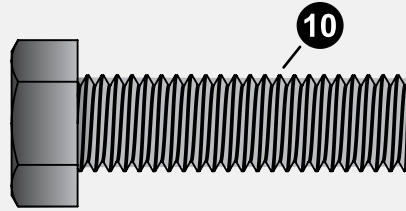

1/2-13 X 1 3/4" HEX BOLT  
1B-6224-10  
**(QTY. 4)**

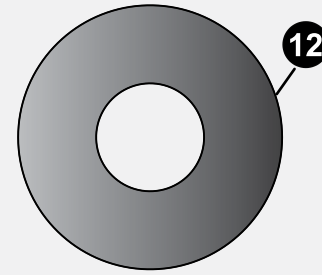

1/2" FLAT WASHER  
2B-6093-10  
**(QTY. 8)**

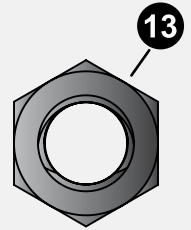

1/2-13 LOCKNUT  
2B-6095-10  
**(QTY. 4)**

### DETAIL A

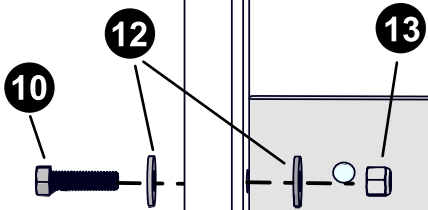

### DETAIL B

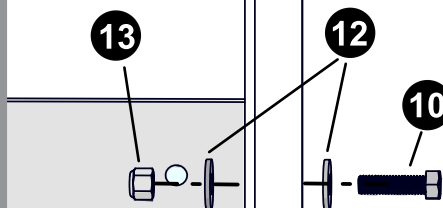

### NOTE

WALL MOUNT (#2) ATTACHES TO  
THE OUTSIDE OF BACKBOARD  
MOUNTING BRACKETS.

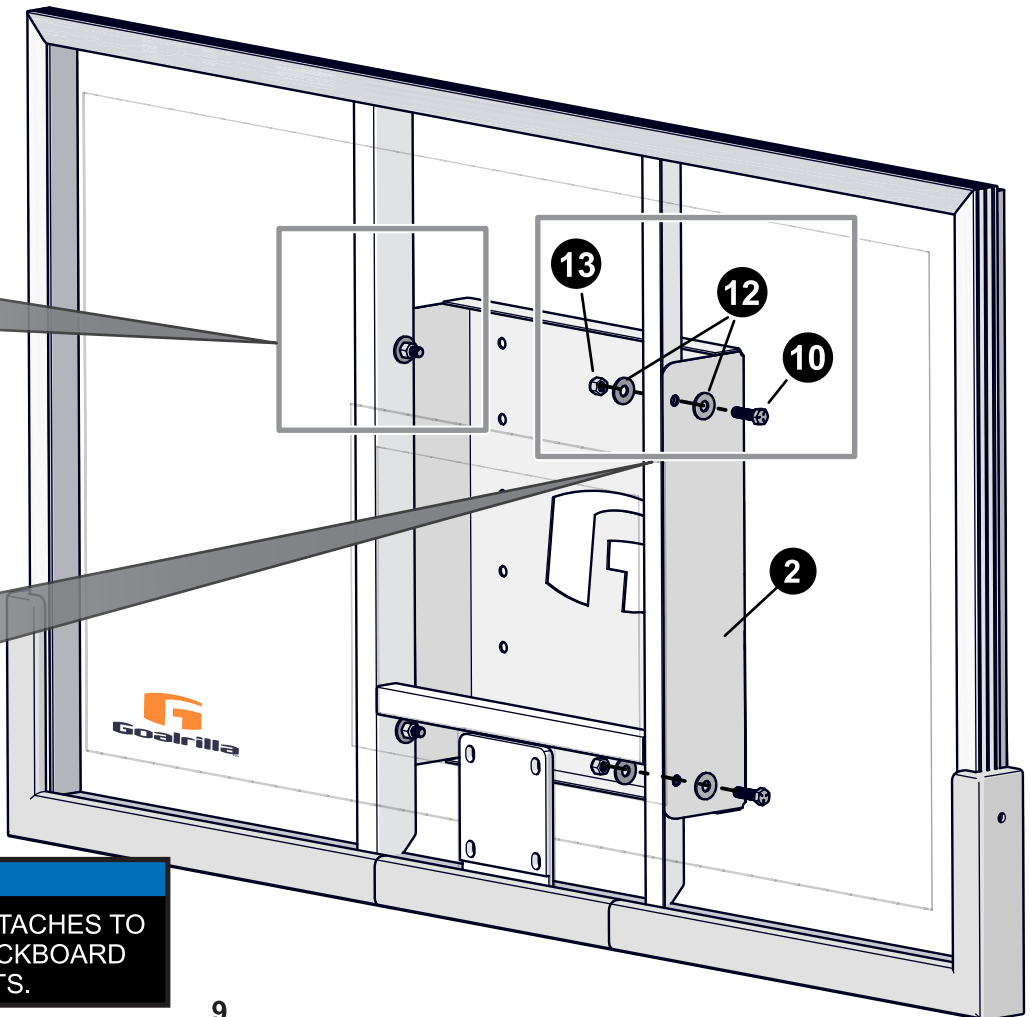

### HARDWARE NEEDED (ACTUAL SIZE)

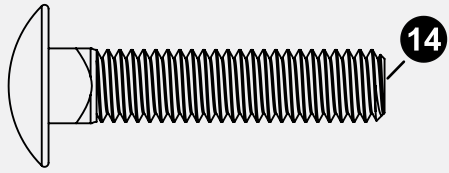

3/8-16 X 1 3/4" CARRIAGE BOLT  
1B-6782-10  
**(QTY. 4)**

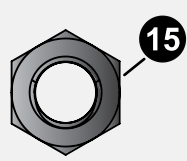

3/8-16 LOCKNUT  
2B-6238-10  
**(QTY. 4)**

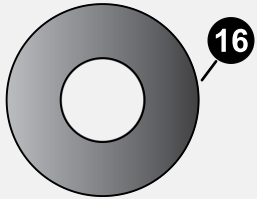

3/8 FLAT WASHER  
2B-6237-10  
**(QTY. 4)**

### TOOLS NEEDED



Ratchet  
with 9/16"  
Socket

**! CAUTION !**  
INSTALL RIM EXACTLY AS SHOWN. FAILURE  
TO DO SO COULD DAMAGE GLASS.

**NOTE**  
MOUNT GOAL ASSEMBLY (#3) TO BACKBOARD AS  
SHOWN. TIGHTEN NUTS (#15) BUT LEAVE LOOSE  
ENOUGH TO LEVEL RIM.

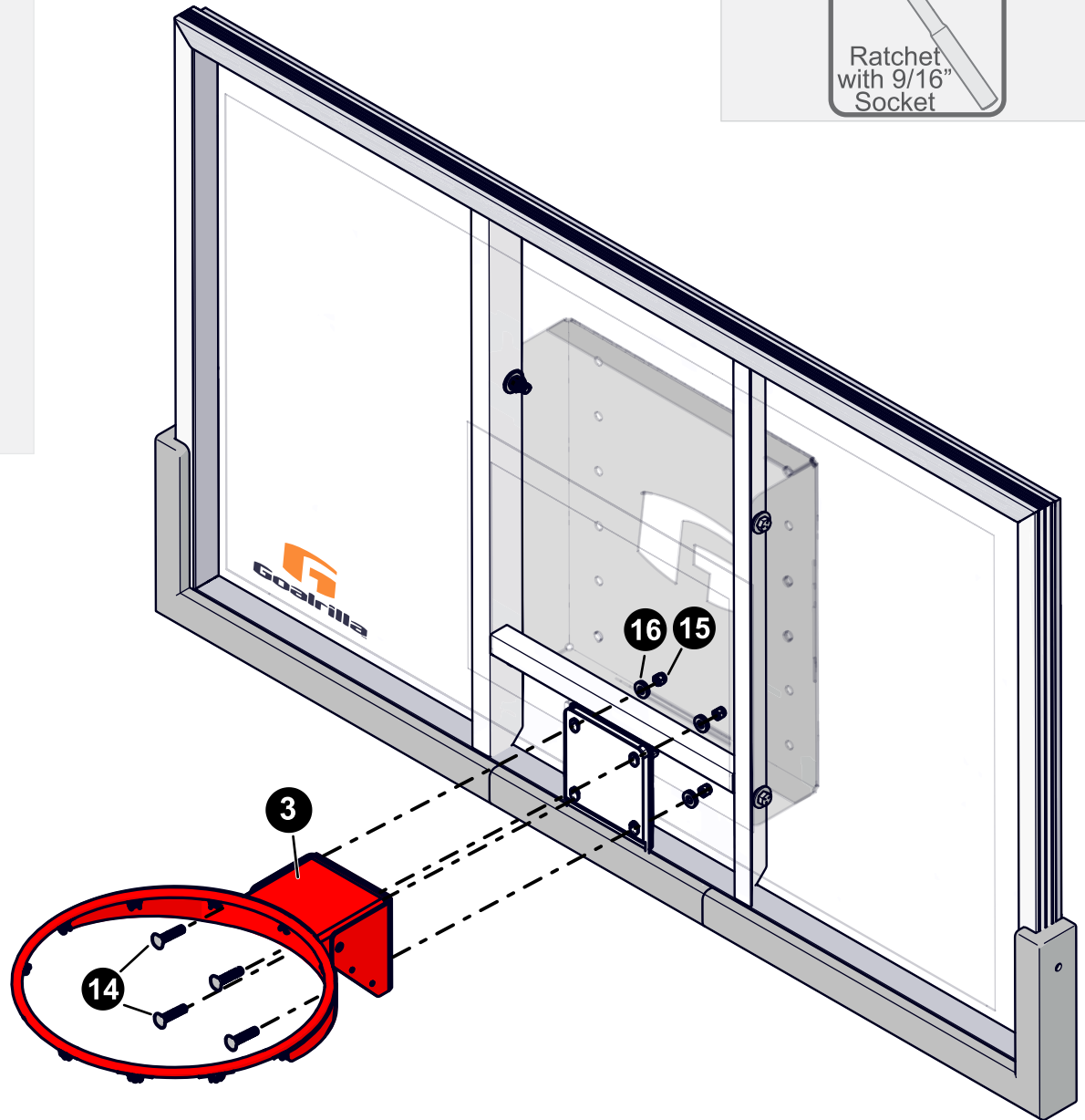

**HARDWARE NEEDED (ACTUAL SIZE)**

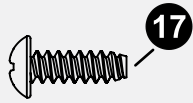

#8 X 1/2" THREAD FORMING SCREW  
1B-6238-01  
**(QTY. 4)**

**NOTE**

LEVEL GOAL ASSEMBLY AND FINISH TIGHTENING NUTS (#15) UNTIL SECURE. ATTACH RIM COVER PLATE (#4) WITH SCREWS (#17) AND NET (#5).

**TOOLS NEEDED**

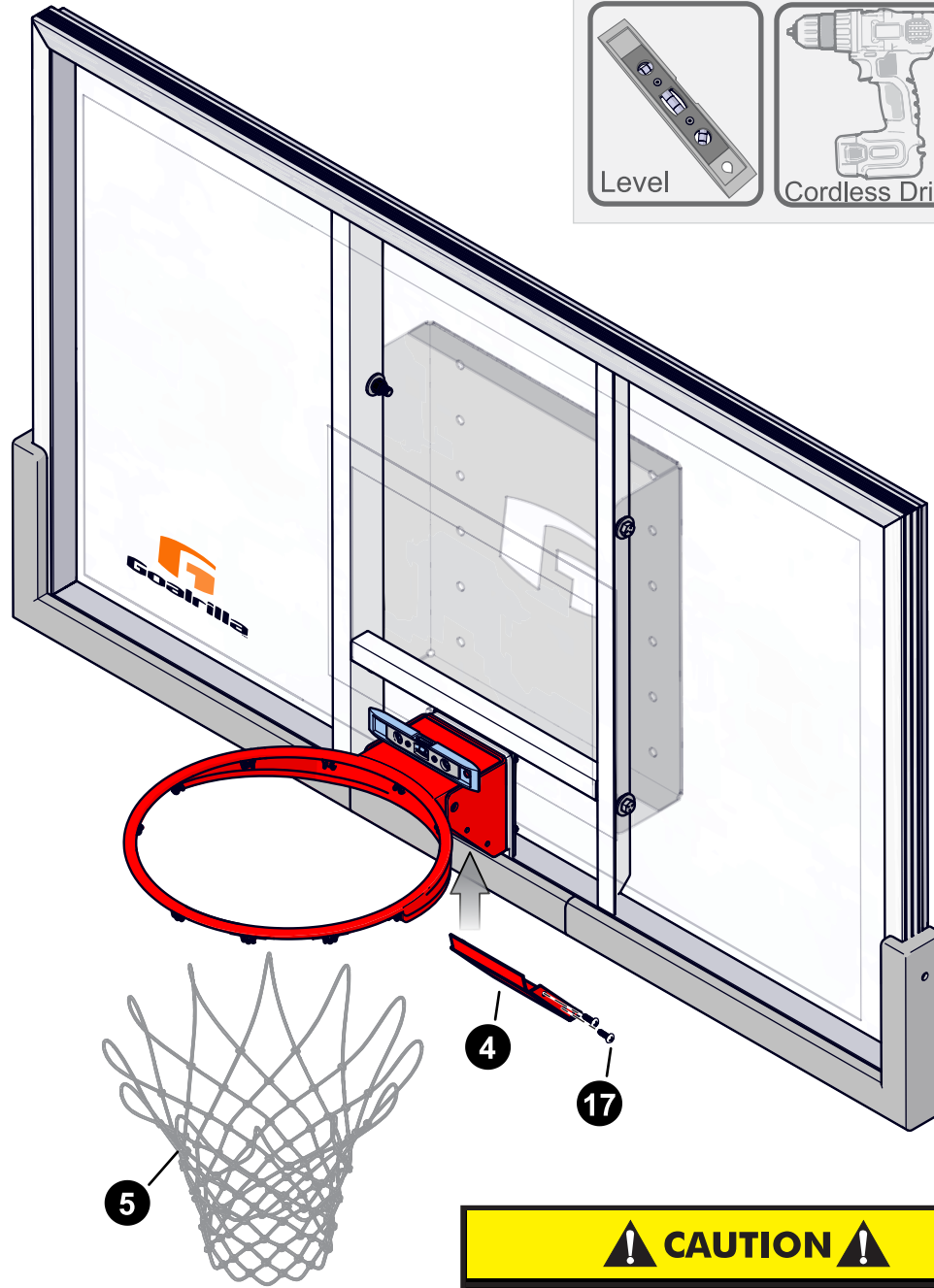
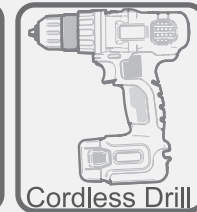
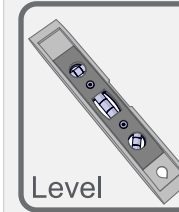

**WARNING:** IMPROPER  
INSTALLATION OR SWINGING  
ON THE RING MAY CAUSE  
SERIOUS INJURY OR DEATH

**! CAUTION !**  
NEVER USE RIM WITH COVERPLATE REMOVED!

## LIMITED LIFETIME WARRANTY

This consumer warranty extends to the original consumer purchase of any Escalade® Sports Product (hereinafter referred to as the "Product").

**WARRANTY COVERAGE:** Escalade® Sports warrants to the original Consumer Purchaser that any Product of its manufacture is free from defects in material and workmanship. THIS WARRANTY IS VOID IF THE PRODUCT HAS BEEN DAMAGED BY ACCIDENT, UNREASONABLE USE, NEGLIGENCE, IMPROPER SERVICE, FAILURE TO FOLLOW INSTRUCTIONS PROVIDED WITH THE PRODUCT OR OTHER CAUSES NOT ARISING OUT OF DEFECTS IN MATERIAL OR WORKMANSHIP.

Subject to proper installation and normal Residential use, Escalade® Sports warrants, subject to the limitations below, to the original retail purchaser all structural components of the Goalrilla™ System to be free of defects in material and workmanship for the duration of ownership by the original retail purchaser.

Merchandise must be shipped prepaid with a copy of proof of purchase to Escalade® Sports factory for examination to determine if the basketball system needs to be repaired or replaced. Any labor costs, travel expenses and any other changes involved in the removal, installation or replacement of the defective/repaired parts from/to your Goalrilla™ System will be the purchaser's responsibility. Shipping charges for replaced or warranted merchandise sent back to the customer from Escalade® Sports factory must be prepaid by the customer in advance. If not, the replacement shipment will be sent out collect.

Escalade® Sports reserves the right to examine photographs or physical evidence of merchandise claimed to be defective, and to recover said merchandise, prior to authorization of warranty claims. A "Returned Goods Authorization" number may be required, please call for details prior to the return of any photographs or merchandise.

This limited lifetime warranty is expressly in lieu of all warranties, expressed or implied, including warranties of merchantability or fitness for use. Escalade® Sports does not assume or authorize any person or representative to assume for us, any other liability in connection with the sale of our products.

The remedy of repair or replacement stated above is Escalade® Sports exclusive remedy. Escalade® Sports will not be liable for any other damages or expenses which may incur, including but not limited to incidental or consequential damages. Escalade® Sports assumes no other obligations or liability on the part of the purchaser, and Escalade® Sports neither assumes nor authorizes any other person to assume for it any other liability in connection with the goods sold.

This warranty shall not apply in any manner to parts or accessories not manufactured by Escalade® Sports.

### NOT COVERED BY THIS WARRANTY

- Merchandise not intended to be in places of public assembly, such as, but not limited to, schools, parks, public or private recreational facilities.
- Any merchandise subjected to Non-residential abuse, negligence, improper installation, vandalism, acts of God, alteration of product, or any other events beyond the control of Escalade® Sports.
- Paint or rusted parts. If rust should appear, remove loose paint, sand lightly, primer and paint with exterior flat matte finish enamel paint.
- Rims are not warranted for any defects other than workmanship. Torn back plates, damaged springs, bent rings, damaged eyebolts, and torn or distorted rim supports result from hanging on the rim and are not warranted.
- Shipping charges both ways. Note: Any merchandise shipped to Escalade® Sports collect will be refused.
- Dealer service charges, labor charges and travel expenses associated with replacement of repair of warranty item.

**WARRANTY DISCLAIMERS:** ANY IMPLIED WARRANTIES ARISING OUT OF THIS SALE, INCLUDING BUT NOT LIMITED TO THE IMPLIED WARRANTIES OF MERCHANTABILITY AND FITNESS FOR A PARTICULAR PURPOSE, ARE LIMITED IN DURATION. ESCALADE® SPORTS SHALL NOT BE LIABLE FOR LOSS OF USE OF THE PRODUCT OR OTHER CONSEQUENTIAL OR INCIDENTAL COSTS. EXPENSES OR DAMAGES INCURRED BY THE CONSUMER OF ANY OTHER USE.

Some states do not allow the exclusion or limitation of implied warranties or consequential or incidental damages, so the above limitations or exclusions may not apply to you.

LEGAL REMEDIES: This warranty gives you specific legal rights, and you may also have other rights which may vary from state to state.

### WARRANTY GUIDELINES IS REQUIRED FOR ALL WARRANTY CLAIMS

1. Proof of Purchase (original retail purchaser) is required for all warranty claims.
2. Call or write Goalrilla® to determine specific needs.

Phone: 1-800-551-443

Or E-mail us at: [information@goalrilla.com.au](mailto:information@goalrilla.com.au)